

盤外天井取付形

形式

CFT5-3164-1
CFT5-3164-2

冷却能力

(50/60Hz)
40/48 (W/K)

● 外形図

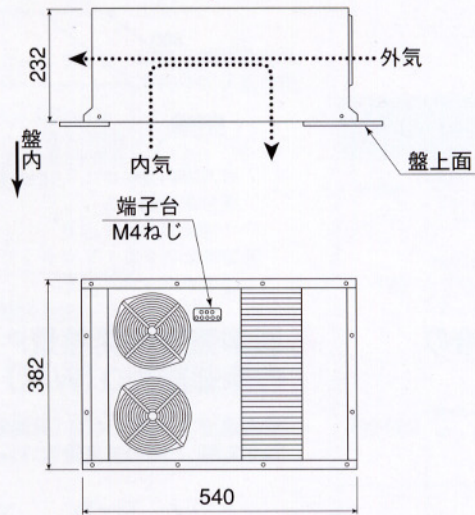

● 取付穴寸法図

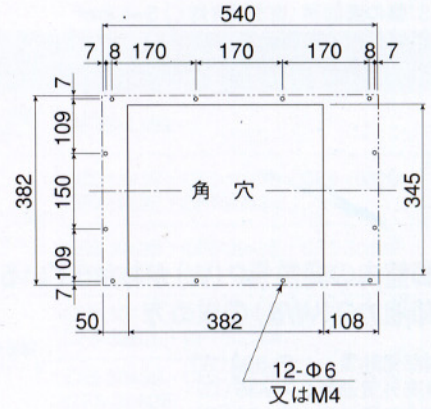

形式

CFT5-4165-1
CFT5-4165-2

冷却能力

(50/60Hz)
50/60 (W/K)

● 外形図

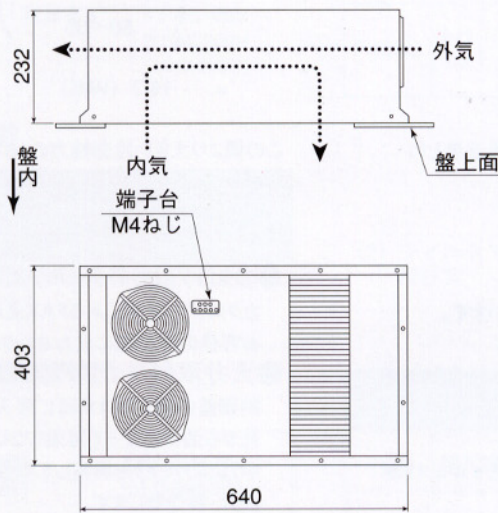

● 取付穴寸法図

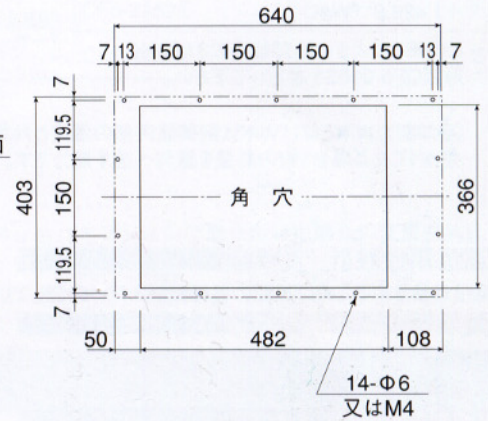

形式

CFT5-4166-1
CFT5-4166-2

冷却能力

(50/60Hz)
60/72 (W/K)

● 外形図

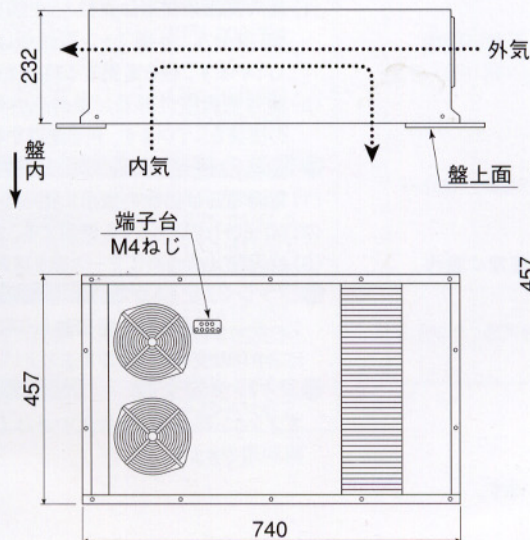

● 取付穴寸法図

